

Varenummer: 201580M825MT
Beskrivelse: E+G Bolt GN 1580-M8-25-MT-H
Hygiejnisk design

Mål

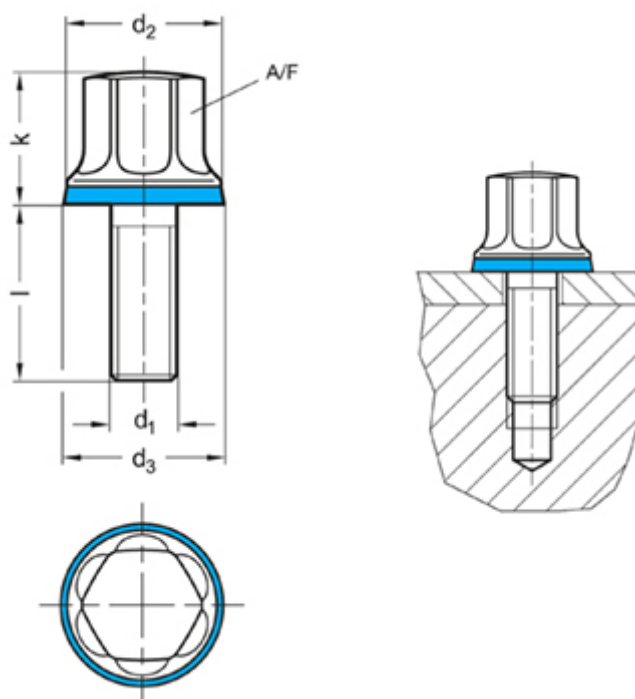

d1	= M 8
d2	= 18
d3	= 18.8
k	= 14.5
L	= 25
t min	= -
Vægt i (g)	= 25